

The following labels are found on HD Motion in standard configuration. Article numbers and sizes for each label are listed in Table 1 on page 4.

Note

* Headings marked with an asterisk indicate that these labels are required for the CE marking to be valid. (For special adaptations and accessories this applies only if the wheelchair is equipped with that adaptation or accessory).

CE-MARKING, MAX USER WEIGHT, AND IDENTIFICATION*

CE label, user weight label, and ID label are placed on the front cross bar of the wheel frame (Figure 1).

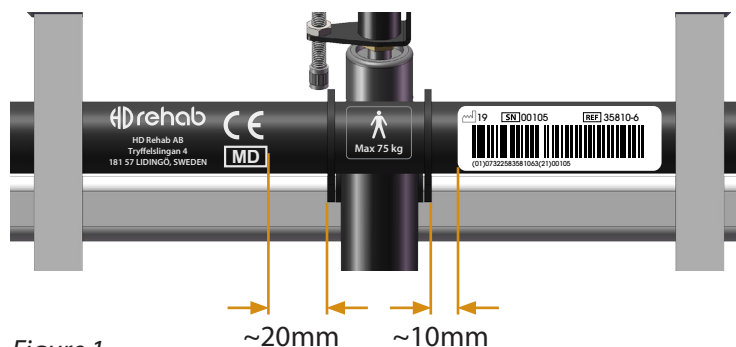

Figure 1

MODEL NAME*

The model label is placed on the rear crossbar of the wheel frame (Figure 2).

- HD motion (22) ||30|| ▲K▼
- HD motion (22) ||30|| ▲L▼
- HD motion (22) ||34|| ▲K▼
- HD motion (22) ||34|| ▲L▼
- HD motion (16) ||30|| ▲K▼
- HD motion (16) ||30|| ▲L▼
- HD motion (16) ||34|| ▲K▼
- HD motion (16) ||34|| ▲L▼

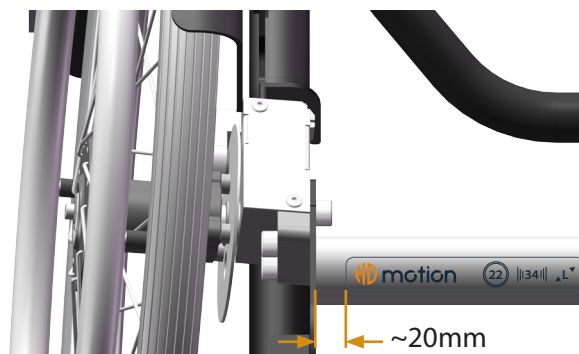

Figure 2

ANCHOR POINTS*

Anchor points are labelled on each side at the front of the wheel frame per Figure 3, and on each fastening bracket at the back per Figure 4 (HD Motion 22) and Figure 5 (HD Motion 16).



Figure 3



Figure 4



Figure 5

LABELLING OF PARKING BRAKES AND TILT CONTROLS

Parking brakes are labelled on the insides of the brake handles, Figures 6 and 7. The back recline control is labelled on the left hand side unit housing (Figure 6) and the seat tilt control on the right hand side unit housing (Figure 7).

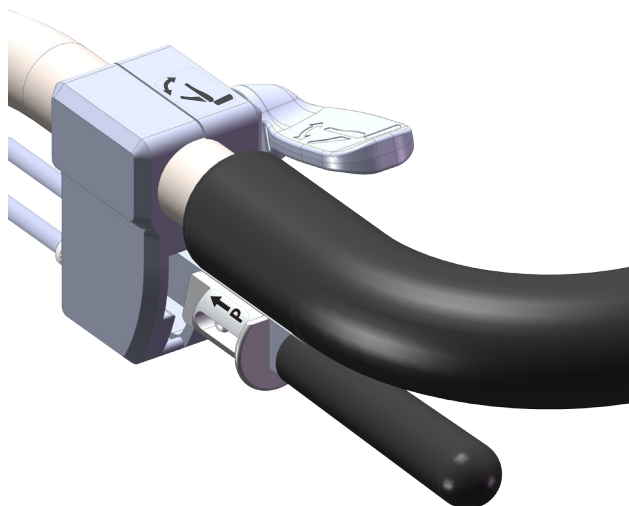

Figure 6

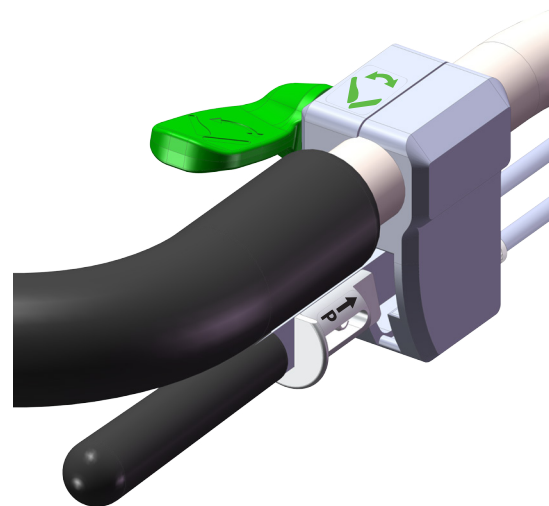

Figure 7

ARMREST BUTTON AND HEIGHT SCALE

A label to indicate the operation of the armrest height adjustment button is placed per Figure 8. A scale indicating the current height of the armrest is placed on the armrest post (Figure 9).

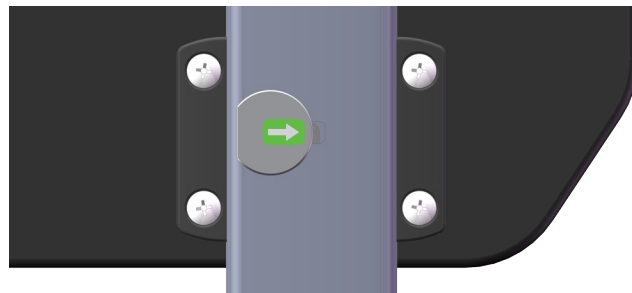

Figure 8

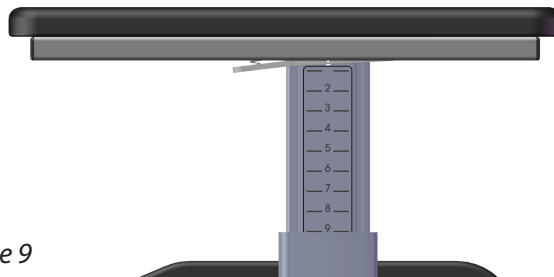

Figure 9

SEAT DEPTH SCALE

A scale indicating the current depth of the seat plate is placed per Figure 10.

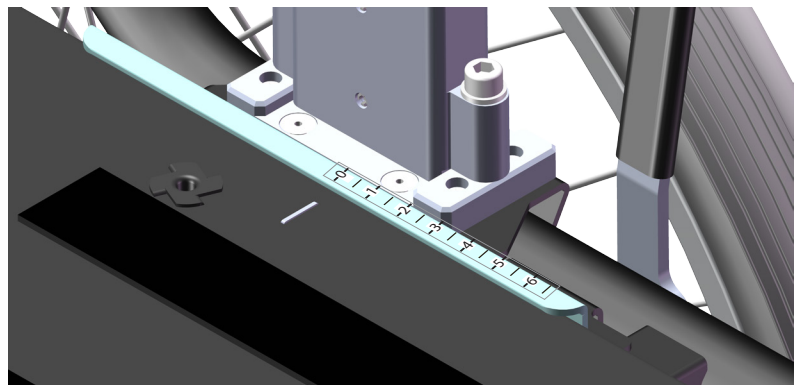
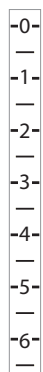

Figure 10

TIP PROTECTOR WARNING LABEL



















Each tip protector has a warning label per Figure 11.



Figure 11

ARTICLE NUMBERS AND SIZES

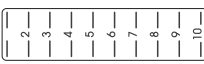
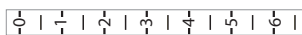
Table 1 - Label article numbers and sizes

Label	Art.nr	Description	Width	Height
	87218	CE label	56	25
	87219	ID label	80	24
	87270-1	Model label 22-30-K	140	20
	87270-2	Model label 22-30-L	140	20
	87270-3	Model label 22-34-K	140	20
	87270-4	Model label 22-34-L	140	20
	87271-1	Model label 16-30-K	140	20
	87271-2	Model label 16-30-L	140	20
	87271-3	Model label 16-34-K	140	20
	87271-4	Model label 16-34-L	140	20
	87206-4	Max User Weight 75 kg	29	24
	87215-5	Anchor point	20	20
	87216-5	Parking brakes	7	18
	87227	Seat tilt	14	14
	87228	Back recline	14	14
	87229	Armrest button	13	8
	87211	Armrest scale	24	95
	87210-5	Seat depth scale	6	70
	87226	Tip protector warning	60	10